

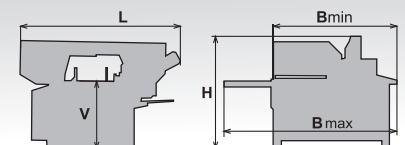





# PEGAS





## 240x280 A-CNC-F



0°



mm	0°	 b a × b	 a b
	260	X	X
	150*	X	X
 a × b	290x260	290x160	230x140
 a × b	290x260	290x160	230x140

	 kW	 m/min	 mm		 kg
3x400V 50 Hz	2,2	20-100	2980x27x0,9		740
L	Bmin	Bmax	Hmin	Hmax	V
1700	1650	2100	1510	2000	910

\*doporučené hodnoty /recommended value



# PEGAS

## 240x280 A-CNC-F

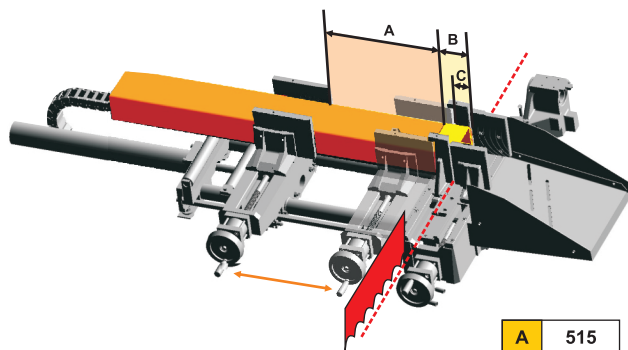

A	515
B	80
C	60

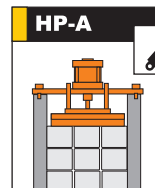
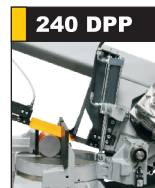
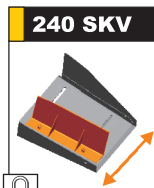
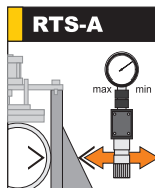
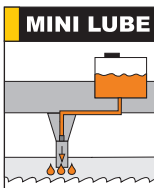
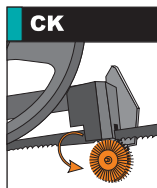

**OPTION**

**RDP-A 700/290**

**240 HP-A**

**LIGHT**

**240 MAL**

30-250 m/min

**240-VTS**

**RBS 200/290**

+RB 200

**RB 200**

**RHS 290**

+RBS + RB

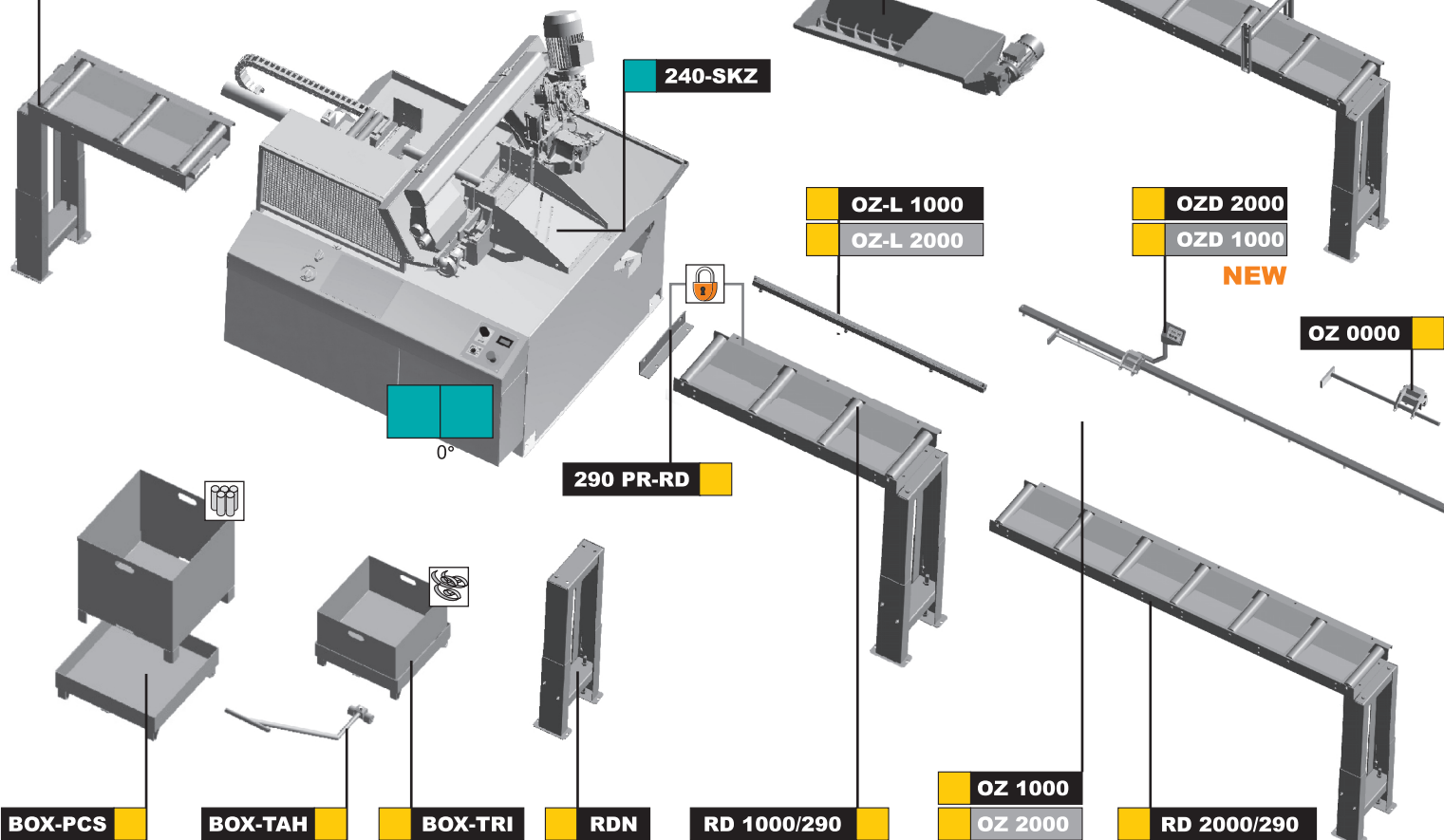

■ STANDARD ■ OPTION



PEGAS-GONDA s.r.o., Čs. armády 322, 684 01 Slavkov u Brna  
Tel: 00420-544 221 125, 00420-544 221 126, fax: 00420 544 227 389  
E-mail: pegas@gonda.cz, [www.pegas-gonda.cz](http://www.pegas-gonda.cz), Czech Republic

- výrobce si vyhrazuje právo provádět změny technických údajů, technické údaje odpovídají 1.12.2010  
- producer has the right to make changes of technical data, technical data are valid on 1.12.2010/  
- pila na fotografii není vždy v základním provedení / the machine in the picture is not always in the basic version  
- uvedené rozměry odpovídají stroji v základním provedení / mentioned diameters are for machine in basic version/