

# 400x400 HERKULES X-CNC

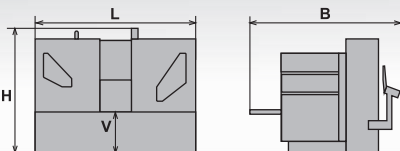
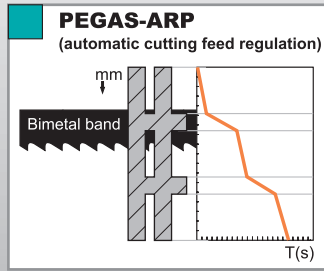
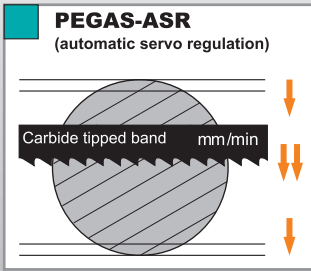

mm	0°	a x b
	400	X
	400*	X
a x b	400x400	400x250
a x b	400x400	400x250

			mm		
3x400V 50 Hz	4,0	20-100	5580x41x1,3		2740
L	Bmax	Bmin	Hmin	Hmax	V
2970	2600	2080	2100	2100	775

\*doporučené hodnoty /recommended values



# PEGAS

## 400x400 HERKULES X-CNC

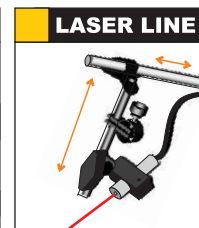
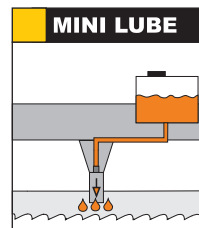
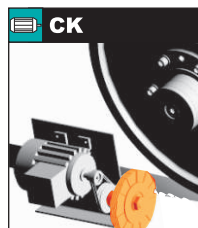
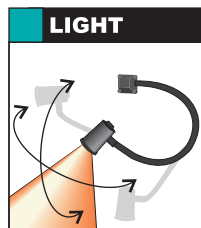

**400 VZM**   
+400 RDT

**400 RBRS**   
+400 RBR

### OPTION

**400 HP-A** 

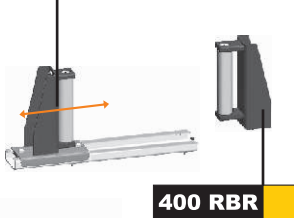
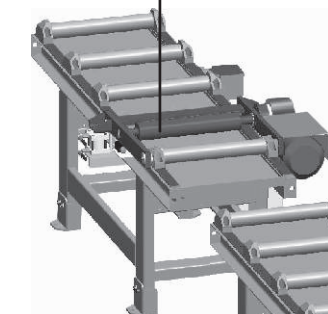
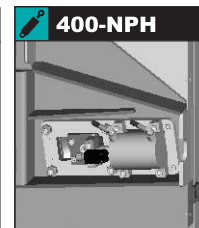
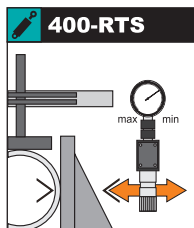
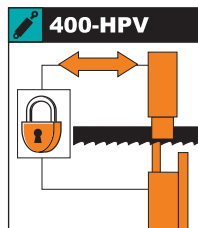

**400 RDT 2000/450**

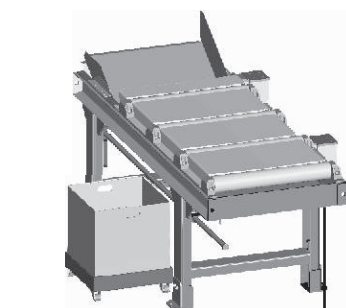

**400 RDZ-SKZ 2000/450**   
+BOX-PCS

**400 RDT 1000/450**

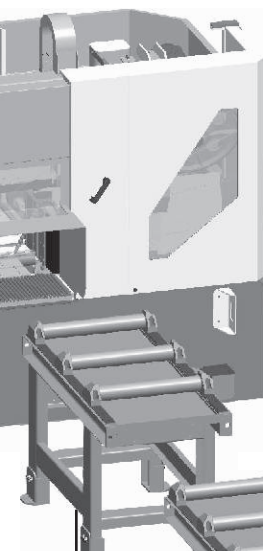

**400 VTS**

**BOX-PCS**

**BOX-TRI**

**BOX-TAH**

**V 450**   
+RDT



**400 RDZ 1000/450**

### 400 VZM:

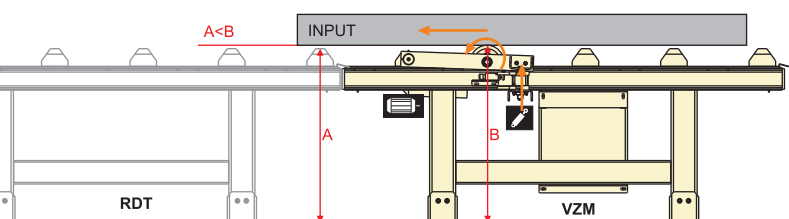

**400 RDT 2000/450**

**400 RDH**

**PEGAS-ABP**  
(automatic band position)

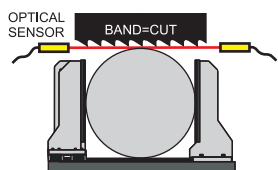

**PEGAS-KKR**  
(indication the position of the blade)

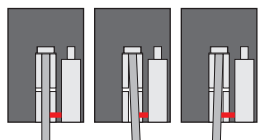

**PEGAS-CMU**  
(contactless movement up)

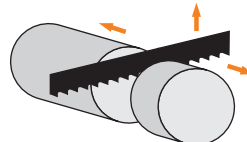

**PEGAS-ATB**  
(automatic transport bar)

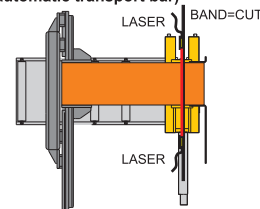

 STANDARD  OPTION

**PEGAS GONDA**  
PILY NA KOV - BAND SAW MACHINES

PEGAS-GONDA s.r.o., Čs. armády 322, 684 01 Slavkov u Brna  
Tel: 00420-544 221 125, 00420-544 221 126, fax: 00420 544 227 389  
E-mail: pegas@gonda.cz, [www.pegas-gonda.cz](http://www.pegas-gonda.cz), Czech Republic

- výrobce si vyhrazuje právo provádět změny technických údajů, technické údaje odpovídají 1.9.2012  
/producer has the right to make changes of technical data, technical data are valid on 1.9.2012/  
- pila na fotografiích není vždy v základním provedení / the machine in the picture is not always in the basic version  
- uvedené rozměry odpovídají stroji v základním provedení / mentioned diameters are for machine in basic version/