

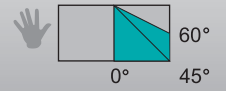









## 240x280 GH-R









mm	0°	45°	60°	 $\frac{b}{a \times b}$
	240	180	110	X
	150*	110*	80*	X
 a x b	270x220	180x140	110x140	270x120
 a x b	250x240	160x240	100x150	270x120

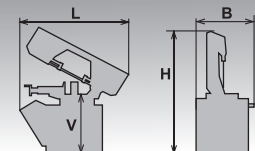
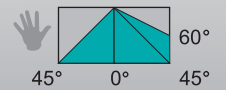



\*doporučené hodnoty/ recommended values

	 kW	 m/min	 mm		 kg
3x400V 50Hz	1,4/2,0	35/70	2980x27x0,9		345
L	B	Hmin	Hmax	V	
1700	970	1500	2020	915	

## 290x320 GH-LR



mm	0°	45°	60°	45°	 $\frac{b}{a \times b}$
	290	240	150	240	X
	180*	110*	80*	110*	X
 a x b	320x290	240x150	150x180	240x100	320x160
 a x b	320x290	210x290	130x290	150x290	320x160

	 kW	 m/min	 mm		 kg
3x400V 50 Hz	1,4/2,0	35/70	3100x27x0,9		540
L	B	Hmin	Hmax	V	
1800	950	1550	2100	940	

\*doporučené hodnoty/ recommended values



# PEGAS

## 240x280 GH-R

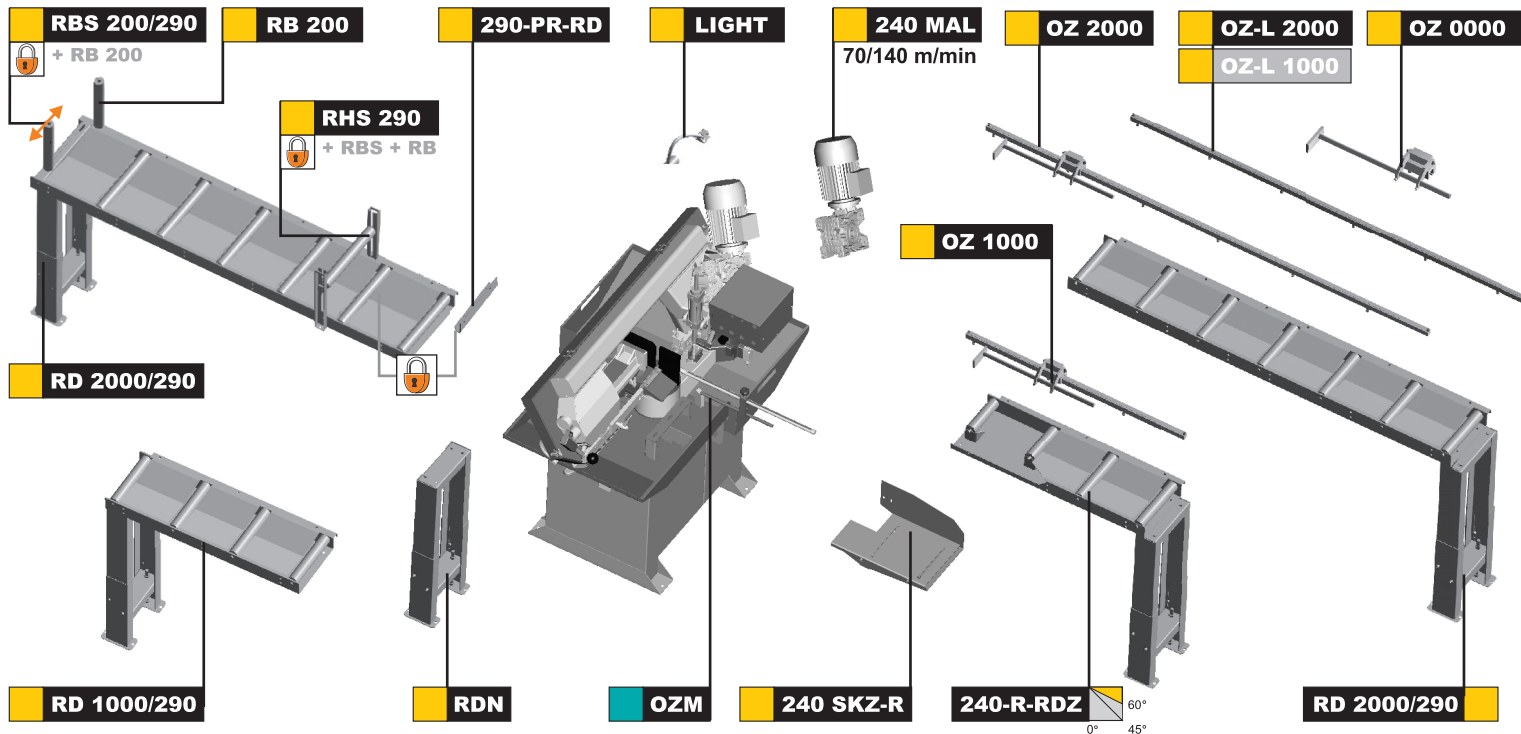
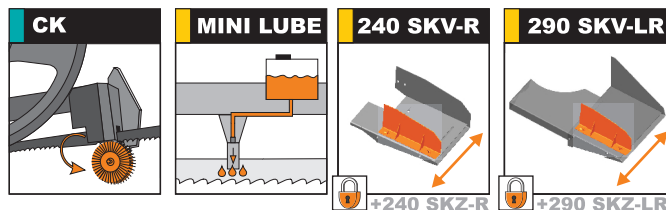

## 290x320 GH-LR

### OPTION

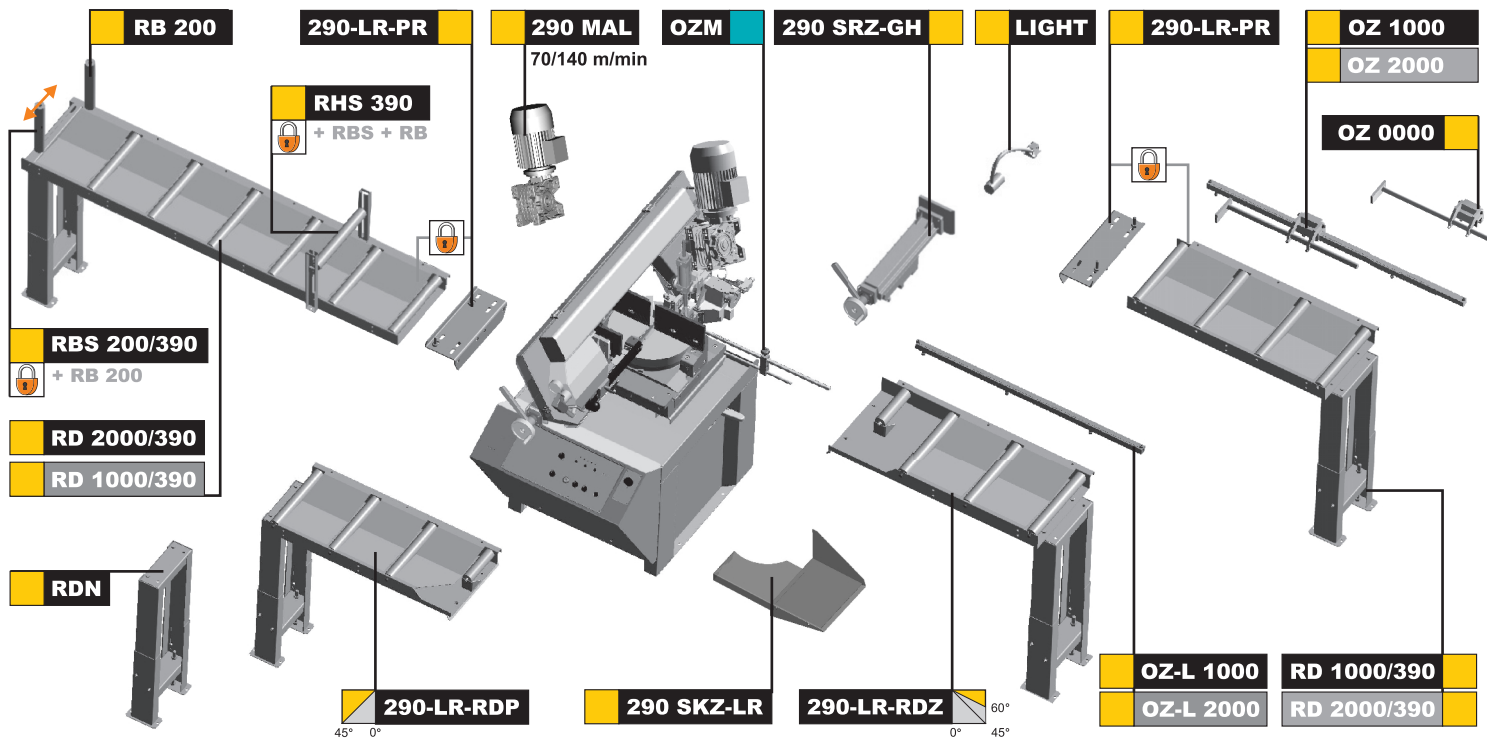

■ STANDARD    ■ OPTION



PEGAS-GONDA s.r.o., Čs. armády 322, 684 01 Slavkov u Brna  
 Tel: 00420-544 221 125, 00420-544 221 126, fax: 00420 544 227 389  
 E-mail: pegas@gonda.cz, [www.pegas-gonda.cz](http://www.pegas-gonda.cz), Czech Republic

- výrobce si vyhrazuje právo provádět změny technických údajů, technické údaje odpovídají 1.9.2009  
 /producer has the right to make changes of technical data, technical data are valid on 1.9.2009/  
 - pila na fotografii není vždy v základním provedení / the machine in the picture is not always in the basic version  
 - uvedené rozměry odpovídají stroji v základním provedení / mentioned diameters are for machine in basic version/