

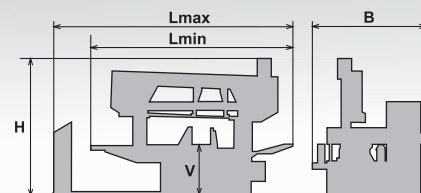

360x600 HORIZONTAL
360x600 HORIZONTAL X

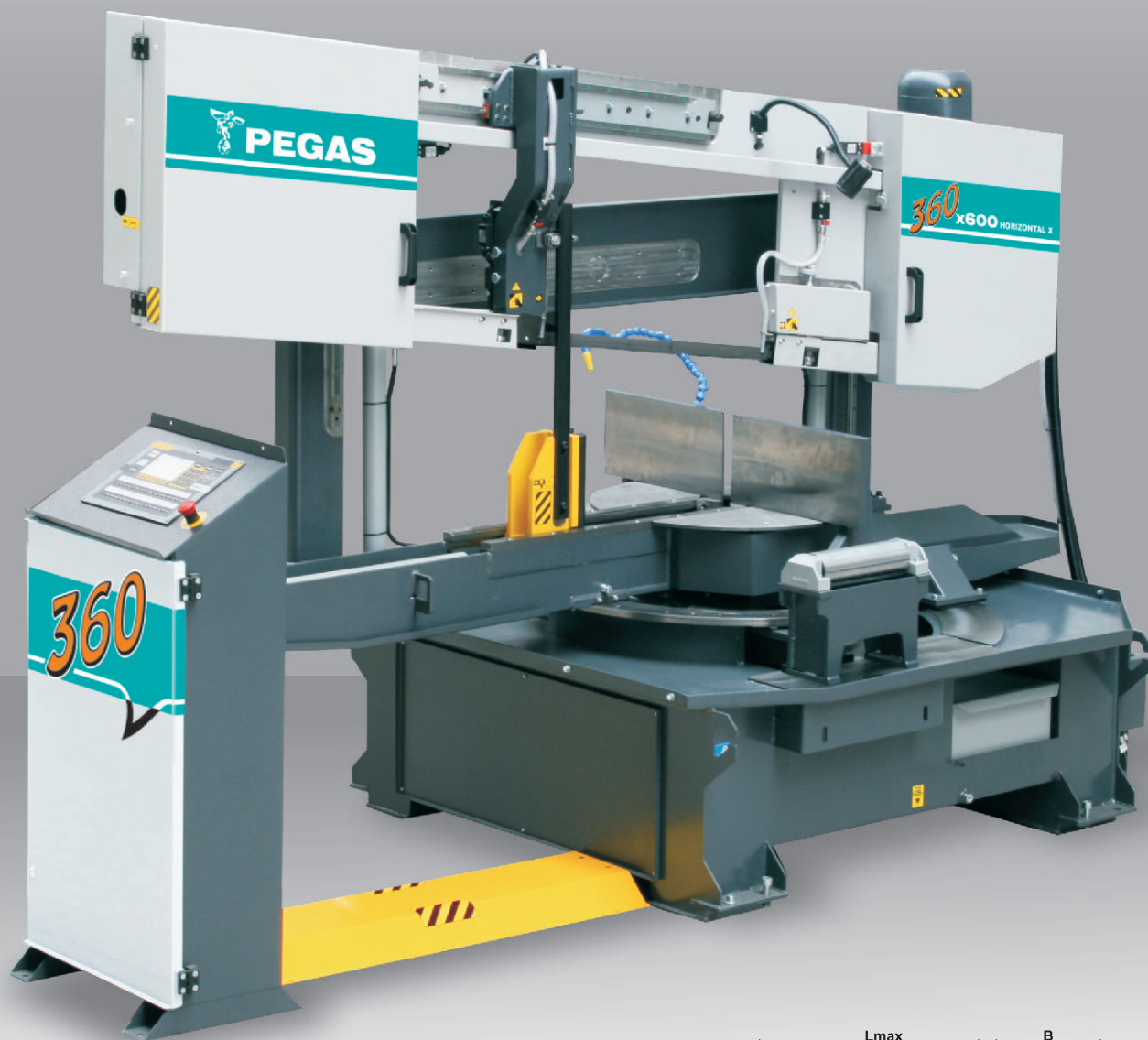
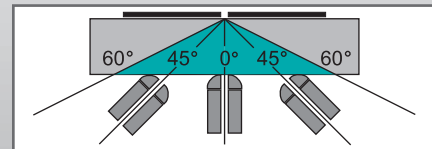
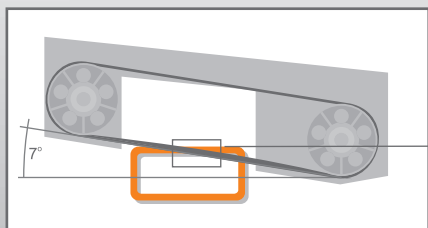

mm	0°	45°	60°	45°	60°	$\frac{b}{a} \times \frac{b}{a \times b}$
	360	380	260	370	260	X
	250*	180*	130*	180*	130*	X
$\frac{a}{a \times b}$	610x360	410x360	260x330	410x360	260x330	600x210

3x400V 50 Hz	3,0	20-100	5715x34x11		1600 1620*
Lmin	Lmax	B	Hmin	Hmax	V
2900	3300	1550	1750	2050	815

*doporučené hodnoty/ recommended values

*360x600 HORIZONTAL X



PEGAS

360x600 HORIZONTAL 360x600 HORIZONTAL X

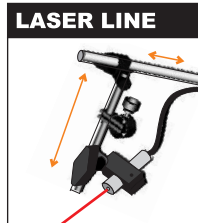
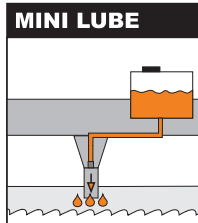
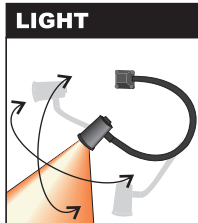
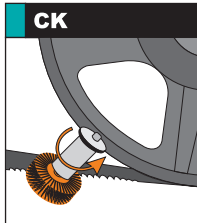

360x600 HORIZONTAL X

360x600 HORIZONTAL X

360x600 HORIZONTAL X

360x600 RDP 2000/620
360x600 RDPM 2000/620

360x600 VZMP

OPTION

500 RDT 1000/620

500 RBRS

360x600-RTS

360x600-NPH

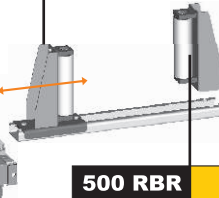
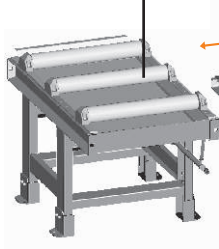
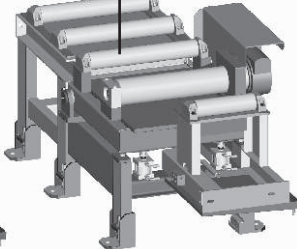
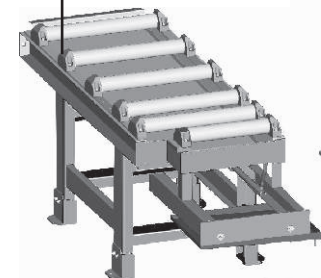

500 RBR

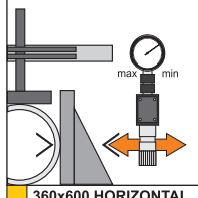

360x600 HORIZONTAL
360x600 HORIZONTAL X

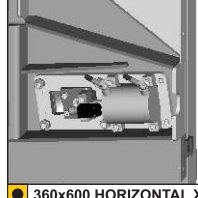

360x600 HORIZONTAL X

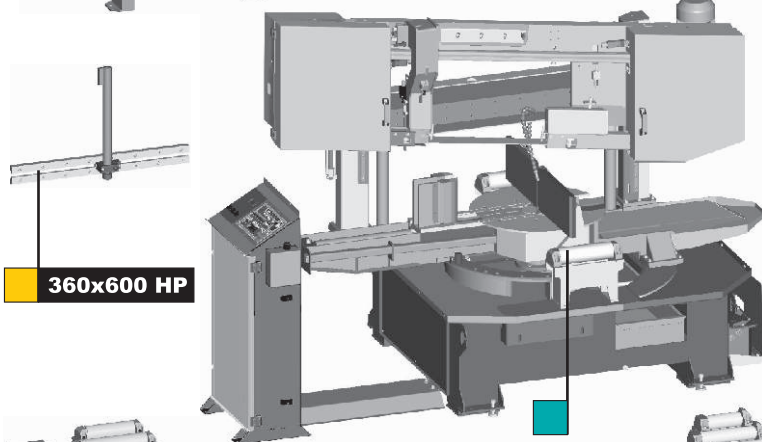

360x600 HP



360x600 HORIZONTAL X

360x600 VTH

BOX-TAH

BOX-PCS

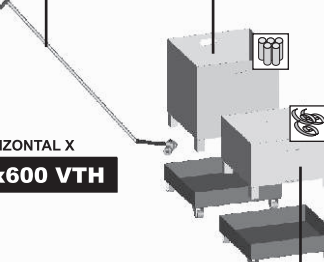

OZP-L 2300 RDZ

OZP-L 2000
OZD-L 1000

OZS 2000
+RDM

OZS-D 2000
+RDM

OZP 2000
OZP 1000

OZP-D 2000
OZP-D 1000

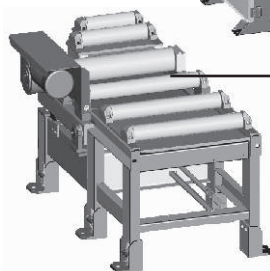

360x600 VZMZ

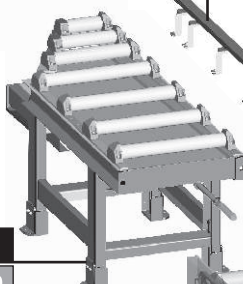

360x600 RDZ 2000/620

360x600 RDZM 2000/620

360x600 HORIZONTAL

360x600 HORIZONTAL X

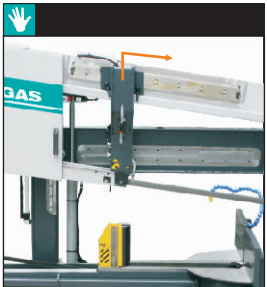

360x600-HPV



360x600-PUH, PUD

500-V
+RDT

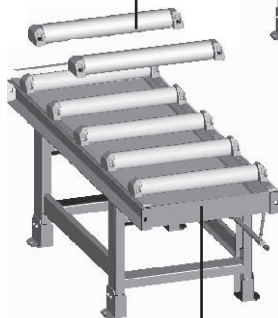

500 RDT 2000/620

500 RDM 2000/620

500 RDML 2000/620
+RDM



STANDARD OPTION
ONLY FOR HORIZONTAL X

PEGAS GONDA
PILY NA KOV - BAND SAW MACHINES

PEGAS-GONDA s.r.o, Čs. armády 322, 684 01 Slavkov u Brna
Tel: 00420-544 221 125, 00420-544 221 126, fax: 00420 544 227 389
E-mail: pegas@gonda.cz, www.pegas-gonda.cz, Czech Republic

- výrobce si vyhrazuje právo provádět změny technických údajů, technické údaje odpovídají 1.9.2012
/producer has the right to make changes of technical data, technical data are valid on 1.9.2012/
- píla na fotografii není vždy v základním provedení / the machine in the picture is not always in the basic version
- uvedené rozměry odpovídají stroji v základním provedení / mentioned diameters are for machine in basic version /